

MITSUBISHI

GT15 BUS CONNECTION UNIT

User's Manual

GT15-75QBUSL  
GT15-75QBUS2L  
GT15-75ABUSL  
GT15-75ABUS2L

Thank you for purchasing the GOT1000 Series.

Prior to use, please read both this manual and detailed manual thoroughly to fully understand the product.

MODEL	GT15-75BUSL-U
MODEL CODE	1D7M04
IB(NA)-0800298-B(0504)MEE	

GRAPHIC OPERATION TERMINAL  
**GOT1000**

SAFETY PRECAUTIONS

(Always read these precautions before using this equipment.)

Before using this product, please read this manual and the relevant manuals introduced in this manual carefully and pay full attention to safety to handle the product correctly.

The precautions given in this manual are concerned with this product. In this manual, the safety precautions are ranked as "DANGER" and "CAUTION".

**DANGER** Indicates that incorrect handling may cause hazardous conditions, resulting in death or severe injury.

**CAUTION** Indicates that incorrect handling may cause hazardous conditions, resulting in medium or slight personal injury or physical damage.

Note that the CAUTION level may lead to a serious accident according to the circumstances. Always follow the precautions of both levels because they are important to personal safety. Please save this manual to make it accessible when required and always forward it to the end user.

DESIGN PRECAUTIONS

CAUTION

- Do not bunch the control wires or communication cables with the main circuit or power wires, or lay them close to each other. As a guide, separate the lines by a distance of at least 100 mm (3.94 inch) otherwise malfunctions may occur due to noise.

INSTALLATION PRECAUTIONS

DANGER

- Before mounting or dismantling this unit to or from the GOT, always shut off GOT power externally in all phases. Not doing so can cause a unit failure or malfunction.

CAUTION

- Use this unit in the environment given in the general specifications of the GT15 User's Manual. Not doing so can cause an electric shock, fire, malfunction or product damage or deterioration.
- When installing this unit to the GOT, fit it to the connection interface of the GOT and tighten the mounting screws in the specified torque range. Undertightening can cause a drop, failure or malfunction. Overtightening can cause a drop, failure or malfunction due to screw or unit damage.

WIRING PRECAUTIONS

DANGER

- Before connecting the Bus connection cable to this unit, always shut off GOT power and PLC CPU power externally in all phases. Not doing so can cause a malfunction.

CAUTION

- Insert and fit the bus connection cable into the connector of the unit to be connected until it "clicks". After fitting, check for lift which can cause a malfunction due to a connection fault.

STARTUP AND MAINTENANCE PRECAUTIONS

DANGER

- Before starting cleaning, always shut off GOT power externally in all phases. Not doing so can cause a unit failure or malfunction.

CAUTION

- Do not disassemble or modify any unit. This will cause failure, malfunction, injuries, or fire.
- Do not touch the conductive areas and electronic parts of this unit directly. Doing so can cause a unit malfunction or failure.
- Always secure the cables connected to the unit, e.g. run them in conduits or clamp them. Not doing so can cause unit or cable damage due to dangling, moved or accidentally pulled cables or can cause a malfunction due to a cable contact fault.
- Do not hold the cable part when unplugging any cable connected to the unit. Doing so can cause unit or cable damage or a malfunction due to a cable contact fault.
- Always make sure to touch the grounded metal to discharge the electricity charged in the body, etc., before touching the unit. Failure to do so may cause a failure or malfunctions of the unit.

DISPOSAL PRECAUTIONS

CAUTION

- Dispose of this product as industrial waste.

TRANSPORTATION PRECAUTIONS

CAUTION

- Make sure to transport the GOT main unit and/or relevant unit(s) in the manner they will not be exposed to the impact exceeding the impact resistance described in the general specifications of the GT15 User's Manual, as they are precision devices. Failure to do so may cause the unit to fail. Check if the unit operates correctly after transportation.

Manuals

The following shows manuals relevant to this product.

Detailed Manual

Manual name	Manual Number (Type code)
GT15 User's Manual (Option)	SH-080528ENG (1D7M23)
GOT1000 Series Connection Manual (Option)	SH-080532ENG (1D7M26)

Relevant Manuals

For relevant manuals, refer to the PDF manual stored within the drawing software used.

© 2004 MITSUBISHI ELECTRIC CORPORATION

Compliance with the EMC and Low Voltage Directives

When incorporating the Mitsubishi GOT into other machinery or equipment and keeping compliance with the EMC and low voltage directives, refer to Chapter 4, "EMC Directives and Low Voltage Directives" of the manual (GT15 General Description) included with the GOT used.

The CE logo is printed on the rating plate of the GOT, indicating compliance with the EMC and low voltage directives. By making this product conform to the EMC directive and low voltage instruction, it is not necessary to make those steps individually.

Product Components

The bus connection unit consists of the following items.

Product name	Quantity
Any one of GT15-75QBUSL, GT15-75QBUS2L, GT15-75ABUSL, GT15-75ABUS2L	1
Seals	12

1. Overview

This User's Manual describes the GT15 bus connection unit (hereafter abbreviated to the bus connection unit). There are the following bus connection unit types. Refer to the GT15 User's Manual for the applicable GOT.

Product name	Model name	Description
Bus connection unit	GT15-75QBUSL	QCPU (Q Mode) bus connection Number of connectors: 1
	GT15-75QBUS2L	QCPU (Q Mode) bus connection Number of connectors: 2
	GT15-75ABUSL	QnA/ACPU bus connection Number of connectors: 1
	GT15-75ABUS2L	QnA/ACPU bus connection Number of connectors: 2

Use the bus connection unit for making bus connection of the GOT. Select the used bus connection unit according to the connection target and connection position.

Bus connection unit selection example

- Select the bus connection unit according to the connection target.

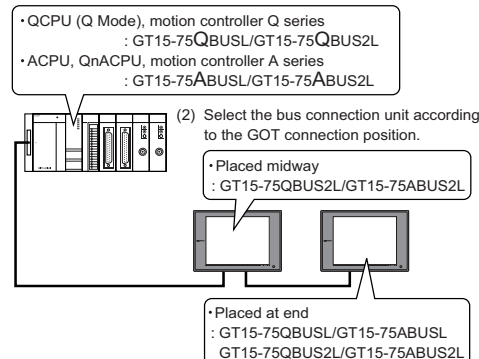

Refer to the GOT1000 Series Connection Manual for details of bus connection.

2. Specifications

The performance specifications of the bus connection unit are indicated below. Refer to the used GT15 User's Manual for the general specifications of the bus connection unit.

Item	GT15-75QBUSL	GT15-75QBUS2L	GT15-75ABUSL	GT15-75ABUS2L
I/O occupied points	16 points (I/O assignment: 16 intelligent points)	32 points (I/O assignment: Special 32 points)		
Internal consumed current (DC5V)*	0.44A	0.44A	0.12A	0.12A
Weight	0.13kg	0.14kg	0.13kg	0.14kg

\* When the GOT power is on, the internal current consumption is included in the current consumption of the GOT. When the GOT power is off, the internal current is supplied from the power supply of the PLC system.

3. Part Names and External Dimensions

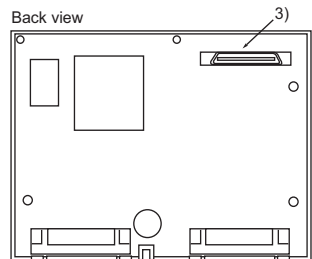
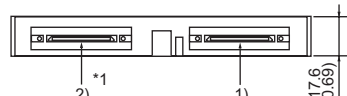
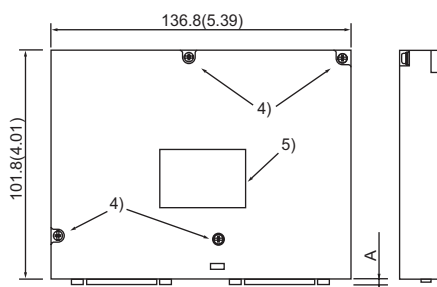

MODEL	A
GT15-75QBUSL	2.3(0.09)
GT15-75QBUS2L	2.3(0.09)
GT15-75ABUSL	3.9(0.15)
GT15-75ABUS2L	3.9(0.15)

Unit: mm (inch)

\*1 When the GT15-75QBUSL/GT15-75ABUSL is used, only the IN side connector is available.

No.	Name	Description
1)	Bus connector (IN side)	Connector for connecting the bus connection cable (IN side)
2)	Bus connector (OUT side)	Connector for connecting the bus connection cable (OUT side)
3)	Extended connector	For connecting the extended connector of the GOT
4)	Mounting screw	Screw (M3 screw) for fixing the unit to the GOT
5)	Rating plate	-

4. Installation Procedure

- Power off the GOT.
- Remove the two expansion unit covers of the GOT.

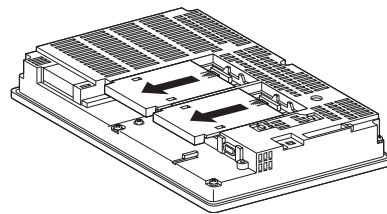

- Fit the bus connection unit along the groove of the GOT case.

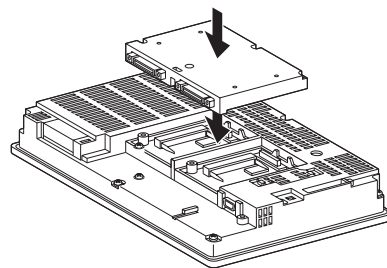

- Fasten the bus connection unit by tightening its mounting screws (4 places) with tightening torque 0.36 to 0.48 N•m.

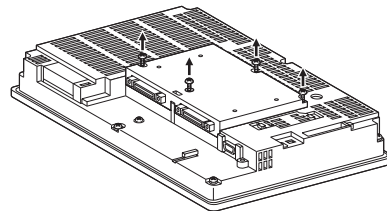

- After tightening screws, attach the supplied seals.

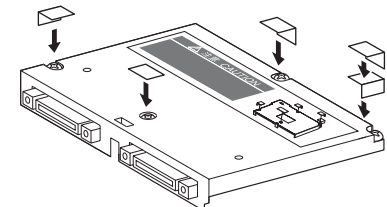

Warranty

Mitsubishi will not be held liable for damage caused by factors found not to be the cause of Mitsubishi; machine damage or lost profits caused by faults in the Mitsubishi products; damage, secondary damage, accident compensation caused by special factors unpredictable by Mitsubishi; damages to products other than Mitsubishi products; and to other duties.

For safe use

- This product has been manufactured as a general-purpose part for general industries, and has not been designed or manufactured to be incorporated in a device or system used in purposes related to human life.
- Before using the product for special purposes such as nuclear power, electric power, aerospace, medicine or passenger movement vehicles, consult with Mitsubishi.
- This product has been manufactured under strict quality control. However, when installing the product where major accidents or losses could occur if the product fails, install appropriate backup or failsafe functions in the system.

Country/Region	Sales office/Tel
U.S.A	Mitsubishi Electric Automation Inc. 500 Corporate Woods Parkway Vernon Hills, IL 60061 Tel : +1-847-478-2100
Brazil	MELCO-TEC Rep. Com.e Assessoria Tecnica Ltda. Rua Correia Dias, 184, Edificio Paraiso Trade Center-8 andar Paraiso, Sao Paulo, SP Brazil Tel : +55-11-5908-8331
Germany	Mitsubishi Electric Europe B.V. German Branch Golthaer Strasse 8 D-40880 Ratingen, GERMANY Tel : +49-2102-486-0
U.K	Mitsubishi Electric Europe B.V. UK Branch Travellers Lane, Hatfield, Herts., AL10 8XB, UK Tel : +44-1707-276100
Italy	Mitsubishi Electric Europe B.V. Italian Branch Centro Dir. Colleoni, Pal. Perseo-Ing.2 Via Paracelso 12, 20041 Agrate B., Milano, Italy Tel : +39-039-6053344
Spain	Mitsubishi Electric Europe B.V. Spanish Branch Carretera de Rubi 76-80 08190 - Sant Cugat del Valles, Barcelona, Spain Tel : +34-93-565-3131
France	Mitsubishi Electric Europe B.V. French Branch 25 Boulevard des Bouvets, F-92741 Nanterre Cedex, France TEL : +33-1-5568-5568
South Africa	Circuit Breaker Industries LTD. Tripswitch Drive, Elandsfontein Gauteng, South Africa Tel : +27-11-928-2000
Hong Kong	Ryoden Automation Ltd. 10th Floor, Manulife Tower, 169 Electric Road, North Point, HongKong Tel : +852-2887-8870
China	Ryoden Automation Shanghai Ltd. 3F Block5 Building Automation Instrumentation Plaza 103 Cao Bao Rd. Shanghai 200233 China Tel : +86-21-6120-0808
Taiwan	Settsuyo Enterprise Co., Ltd. 6F., No.105 Wu-Kung 3rd.RD, Wu-Ku Hsiang, Taipei Hsine, Taiwan Tel : +886-2-2299-2499
Korea	HAN NEUNG TECHNO CO.,LTD. 1F Dong Seo Game Channel Bldg.,660-11, Deungchon-dong Kangseo-ku, Seoul, Korea Tel : +82-2-3660-9552
Singapore	Mitsubishi Electric Asia Pte. Ltd. 307 Alexandra Road #05-01/02, Mitsubishi Electric Building Singapore 159943 Tel : +65-6473-2308
Thailand	F. A. Tech Co.,Ltd. 888/28,29,30 S.V.City Building,Office Tower 2, Floor 17-18 Rama 3 Road, Bangkokpong, Yannawa, Bangkok 10120 Tel : +66-2-692-8522
Indonesia	P.T. Autotekindo SUMBER MAKMUR Jl. Muara Karang Selatan Blok a Utara No.1 Kav. No.11 Kawasan Industri/Pengudangan Jakarta - Utara 14440 Tel : +62-21-653-0833
India	Messung Systems Pvt.Ltd. Electronic Sadan NO:111 Unit No15, M.I.D.C BHOSARI, PUNE-411026, India Tel : +91-20-712-2807
Australia	Mitsubishi Electric Australia Pty. Ltd. 348 Victoria Road, PostalBag, No 2, Rydalmere, N.S.W 2116, Australia Tel : +61-2-9684-7777

MITSUBISHI ELECTRIC CORPORATION  
HEAD OFFICE : 1-8-12, OFFICE TOWER 2 14F HARUMI CHUO-KU 104-6212 JAPAN  
NAGOYA WORKS : 1-14, YADA-MINAMI 5-CHOME, HIGASHI-KU, NAGOYA, JAPAN

When exported from Japan, this manual does not require application to the Ministry of Economy, Trade and Industry for service transaction permission.

Specifications subject to change without notice. Printed in Japan on recycled paper.